

Owner's Guide for the

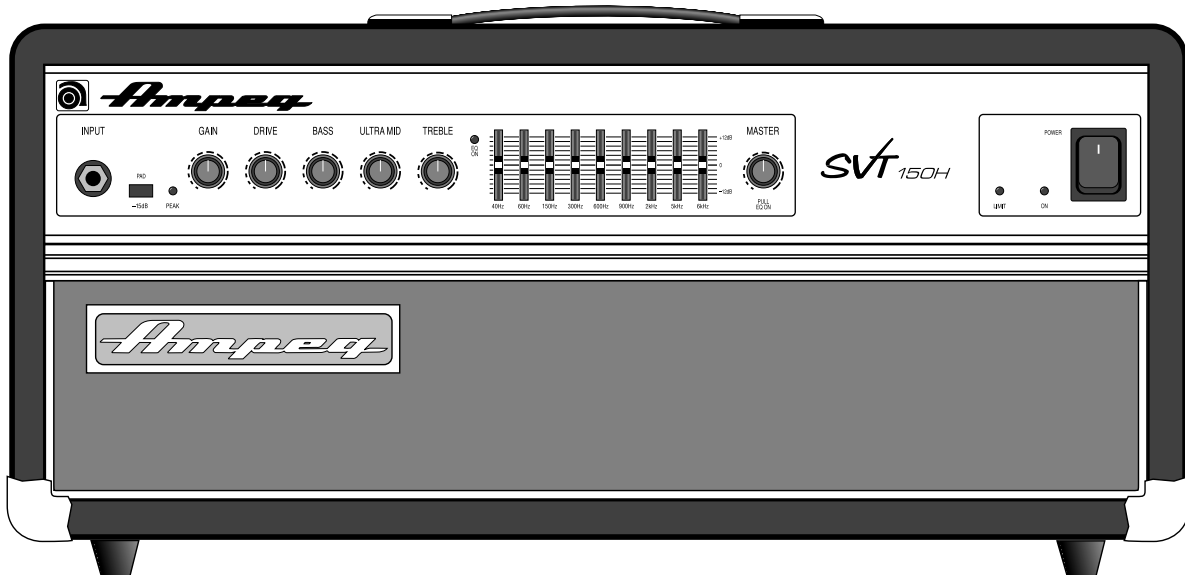

SVT-150H Bass Amplifier



Made in the U.S.A.
by





TABLE OF CONTENTS

Introduction 2
Features 2
Important Safeguards and Precautions 2
The Front Panel Controls and Their Use 3,4
The Rear Panel 4,5
Some Suggested Settings 6
Troubleshooting 7
System Block Diagram 7
Technical Specifications back cover

An Introduction to your new Ampeg SVT-150H Bass Amplifier

First of all, thank you for making what could be one of the best choices you could ever make concerning your musical career - choosing one of the finest bass amplifiers available, an Ampeg SVT-150H.

Your new bass amplifier offers you many outstanding features, such as 150 watts of pure bass energy, total tone control and rugged construction which make it a true performer's bass amp.

Features

In the world of high performance bass amps, Ampeg amplifiers stand alone. In true Ampeg tradition, your new SVT-150H offers you more power, performance and flexibility than any other bass amplifier in its class.

- 9-BAND GRAPHIC EQ: Use as a "second channel" for bass solos, or to shape your sound to your own exacting standards.
• BALANCED LINE OUTPUT: XLR with independent level control switch to patch into house consoles, mixing boards, or external power amplifiers.
• EFFECTS LOOP: For increased intensity and quieter operation of external effects.
• DRIVE CONTROL: To add harmonic content for tube-like overdrive.

Important Safeguards and Precautions

All Ampeg products are designed for continuous safe operation, as long as common sense is used and steps are taken to help avoid certain problems. Abiding by the following rules can help prevent damage to your amplifier, yourself and others.

- The amplifier is equipped with a three-pronged AC power cord. To reduce the risk of electrical shock, NEVER remove or otherwise attempt to defeat the ground pin of the power cord.
• Connect the amplifier ONLY to a properly grounded AC outlet of the proper voltage for your amp.
• Avoid sudden temperature extremes, rain and moisture. Also, avoid sudden and intense impact.
• NEVER set the amplifier on a support that might give out under its weight.
• Always keep the total speaker impedance at or above the rated load.
• Unplug the amplifier before cleaning it. NEVER spray liquid cleaners onto the amplifier.
• Don't use the amplifier if it has sustained damage to the chassis, controls, or power cord.
• Amplifiers capable of producing high volume levels are also capable of inflicting permanent hearing loss or damage, if the exposure to such levels is prolonged.

Three warning boxes: CAUTION (Risk of Electric Shock), ATTENTION (Risque d'Electrocution), and VORSICHT (Elektrische Schlaggefahr). Each box includes a lightning bolt icon and a warning symbol.

THIS EQUIPMENT HAS BEEN DESIGNED AND ENGINEERED TO PROVIDE SAFE AND RELIABLE OPERATION. IN ORDER TO PROLONG THE LIFE OF THE UNIT AND PREVENT ACCIDENTAL DAMAGES OR INJURY, PLEASE FOLLOW THESE PRECAUTIONARY GUIDELINES:
WARNING: TO REDUCE THE RISK OF ELECTRIC SHOCK, DO NOT OPEN CHASSIS; DO NOT DEFEAT OR REMOVE THE GROUND PIN OF THE POWER CORD; CONNECT ONLY TO A PROPERLY GROUNDED AC POWER OUTLET.
CAUTION: TO REDUCE THE RISK OF FIRE OR ELECTRIC SHOCK, DO NOT EXPOSE THIS EQUIPMENT TO RAIN OR MOISTURE.
CAUTION: NO USER-SERVICEABLE PARTS INSIDE. REFER SERVICING TO QUALIFIED SERVICE PERSONNEL.
CAUTION: OUR AMPLIFIERS ARE CAPABLE OF PRODUCING HIGH SOUND PRESSURE LEVELS. CONTINUED EXPOSURE TO HIGH SOUND PRESSURE LEVELS CAN CAUSE PERMANENT HEARING IMPAIRMENT OR LOSS.

Table with 4 columns: SOUND LEVEL dBA SLOW RESPONSE, DURATION PER DAY IN HOURS, SOUND LEVEL dBA SLOW RESPONSE, DURATION PER DAY IN HOURS. Rows show values for 90, 92, 95, 97, 100 dB and 102, 105, 110, 115 dB.

According to OSHA, any exposure in excess of those listed above could result in some hearing loss.

EXPLANATION OF GRAPHICAL SYMBOLS: [Lightning bolt symbol] = "DANGEROUS VOLTAGE" / "DANGER HAUTE TENSION" / "GEFAHLICHE SPANNUNG"
[Warning symbol] = "IT IS NECESSARY FOR THE USER TO REFER TO THE INSTRUCTION MANUAL" / "REFERREZ-VOUS AU MANUAL D'UTILISATION" / "UNBEDINGT IN DER BETRIEBUNGSANLEITUNG NACHSCHLAGEN"

The Front Panel Controls and Their Use

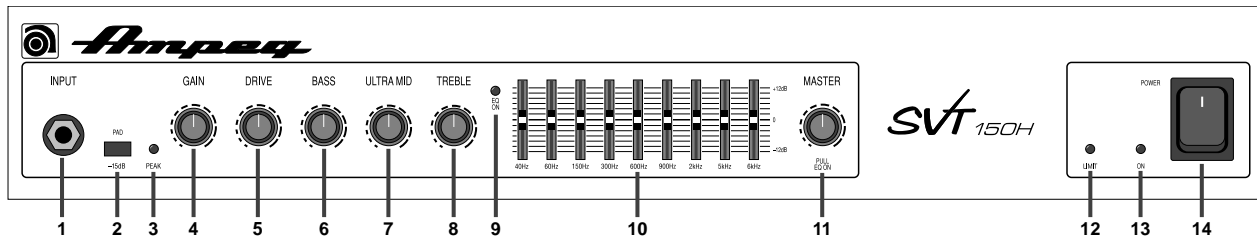

1. INPUT: Connect your bass guitar here using a shielded instrument cable.

2. -15dB PAD: If your bass has high-output pickups or active electronics you may notice the Peak LED (#3) flashes or stays on even at low settings of the Gain control (#4). To keep the signal clean, switch in the Pad. This will attenuate the input signal to the preamp allowing you to get the best signal to noise ratio for your bass.

3. PEAK LED: This LED lights whenever any preamp stage is near the point of being overdriven. Adjust the Gain control (#4) until a strong signal from your bass causes this LED to flicker.

NOTE: If the LED stays on with the Gain at a low setting, use the 15dB Pad (#2) to attenuate the input signal and readjust the Gain.

4. GAIN: This serves as the input level control for the amplifier. For the best signal-to-noise ratio set this control so the Peak LED (#3) flashes when you strike a string fairly hard.

5. DRIVE: This control is used to overdrive the preamp in order to get various harmonic enhancement or distortion sounds. In the fully counterclockwise position the preamp is in the cleanest condition. As the control is rotated

clockwise, signal level is increased to drive the preamp harder (into distortion). The tone of the signal is also changed to provide a smoother overdrive. The tone controls may have to be readjusted to obtain the overall desired tone. The Gain control (#4) and -15dB Pad (#2) interact with the Drive control. For greater overdrive, the Pad switch should be out and the Drive control fully clockwise. Use the Gain control to set the amount of overdrive desired. The Peak LED (#3) will glow steadily when the amp is used in this manner.

6. BASS: This knob serves as the primary low frequency control. This allows for a range of 8dB of cut or boost at 50Hz.

7. ULTRA-MID: This is the primary midrange control. Rotate the control to the left of center for a "contoured" sound (more distant, less midrange output) or to the right of center for a sound that really cuts through.

8. TREBLE: This knob serves as the primary high frequency control. This allows for a range of 17dB boost or 22dB cut at 5kHz.

9. EQ ON LED: This LED indicator lights when you engage the EQ by the front panel Master control (#11) or the footswitch (#23, rear panel).

10. GRAPHIC EQ: These slide controls allow you to adjust the output of the frequencies shown beside each control. The center position of each control is flat (no boost or cut). These controls only affect the sound when the EQ is turned on.

11. MASTER: Set the overall output level of the amplifier with this control. The Effects Loop and Balanced Out (#18, 19, 22) are not affected by the Master control. Pulling the Master control turns on the Graphic EQ (#10). When the footswitch is used, the front panel switch is bypassed.

12. LIMIT LED: This LED indicator will flash on any time the internal limit circuit is called upon to keep amplifier's output signal clean. This indicates that the amplifier is nearing full output and the limiter is keeping it from clipping the output signal.

13. POWER ON LED: This LED indicator lights when the POWER switch (#14) is turned on.

14. POWER SWITCH: This heavy-duty rocker switch applies AC power to the amplifier: the amp is ON in the up position, OFF in the down position.

1. ENTRADA: Conecte aquí su guitarra de bajos usando un cable blindado para instrumentos.

2. TERMINAL DE -15 dB: Si su bajo tiene captadores de alta salida ó circuitos electrónicos activos, usted tal vez notará que el diodo (LED) de Picos (#3) parpadea ó permanece iluminado aún en posiciones bajas del control de Ganancia (#4). Conecte esta Terminal para conservar limpia la señal. Esto atenuará la señal de entrada hacia el preamplificador, lo que le permitirá obtener la mejor relación de señal-a-ruido para su bajo.

3. DIODO (LED) DE PICOS: Este LED se iluminará cuando cualquier etapa de preamplificación se encuentre cerca del punto de sobreimpulso. Ajuste el control de Ganancia (#4) hasta que una señal fuerte de su bajo cause un parpadeo de este LED.

NOTA: Si el LED permanece iluminado aún con la Ganancia en una posición baja, utilice la Terminal de -15 dB (#2) para atenuar la señal de entrada y reajuste la Ganancia.

4. GANANCIA: Esto sirve como el control de nivel de entrada para el amplificador. Para lograr la mejor relación de señal-a-ruido fije este control para que el LED de Picos (#3) parpadee cuando usted pulse con fuerza alguna cuerda.

5. IMPULSO: Este control se usa para sobreimpulsar el preamplificador a fin de conseguir varios realces armónicos ó sonidos de distorsión. En la posición totalmente contraria a las manecillas del reloj, el preamplificador se encontrará en la posición más "limpia". Conforme el control se gire a favor de las manecillas del reloj, el nivel de la señal se

incrementará para impulsar el preamplificador con mayor fuerza (hacia la distorsión). El tono de la señal también cambia para proveer un sobreimpulso más suave. Tal vez tengan que ajustarse los controles de tono para obtener el tono general deseado. El control de Ganancia (#4) y la Terminal de -15 dB (#2) interactúan con el control de Impulso. Para un sobreimpulso mayor, el interruptor de la Terminal debe estar apagado y el control de Impulso totalmente a favor de las manecillas del reloj. Use el control de Ganancia para fijar la cantidad deseada de sobreimpulso. El diodo LED de Picos (#3) se iluminará en forma constante cuando el amplificador se utilice de esta manera.

6. BAJOS: Esta perilla sirve como el control primordial para las frecuencias bajas. Esto permite un rango de 8dB de recorte ó de refuerzo a 50Hz.



The Front Panel Controls and Their Use

7. ULTRA-MEDIANOS: Este es el control primordial para el rango de las frecuencias medianas. Gire el control del centro hacia la izquierda para lograr un sonido de contorno (más distante, menor salida en el rango mediano) ó del centro hacia la derecha para obtener un sonido realmente penetrante.

8. AGUDOS: Esta perilla sirve como el control primordial para las frecuencias altas. Esto permite un rango de 17 dB de refuerzo ó 22dB de recorte a 5kHz.

9. EQ EN LED: Este LED indicador se ilumina cuando usted activa el EQ mediante el control Maestro (#11) del panel delantero ó el interruptor de pie (#23) del panel posterior.

10. EQ GRAFICO: Estos controles deslizantes (cursores) le permiten ajustar la salida de las frecuencias que se muestran junto a cada control. La posición central de cada control es plana (sin refuerzo ni recorte). Estos controles sólo afectan el sonido cuando el EQ esté prendido.

11. MAESTRO: Fije mediante este control el nivel general de salida del amplificador. El Circuito de Efectos y la Salida Equilibrada (#18, 19, 22) no se verán afectadas por el control Maestro. Jalando el control Maestro se prende el EQ Gráfico (#10). Cuando se utiliza el interruptor de pie, se pasa por alto el interruptor del panel delantero.

12. DIODO LED DE LIMITE: Este LED indicador parpadeará cada vez que se requiera el circuito limitador interno para conservar limpia la señal de salida del amplificador. Esto indica que el amplificador está aproximándose a su salida máxima y que el limitador está impidiendo el aplanamiento ("clipping") de la señal de salida.

13. DIODO LED DE POTENCIA ENCENDIDA: Este LED indicador se ilumina cuando se prende el interruptor de POTENCIA (#14).

14. INTERRUPTOR DE POTENCIA: Este interruptor de servicio pesado tipo vaivén aplica la energía de CA al amplificador: el amplificador se PRENDE en la posición hacia arriba, y se APAGA en la posición hacia abajo

The Rear Panel

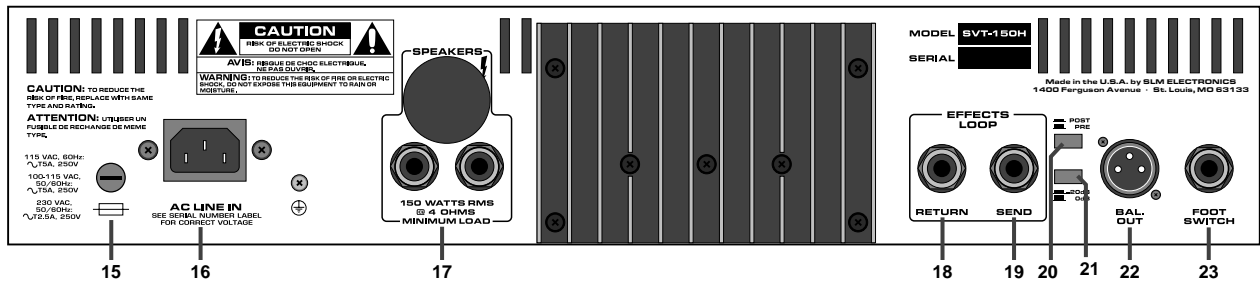

15. FUSE: This protects the unit from damage due to overload conditions or power line surges. If the fuse blows, replace it only with the same size and type.

16. AC LINE IN: Firmly plug the supplied AC power cord into this socket, pushing it in until it is fully seated. Plug the male end of the cord into a grounded AC outlet. **DO NOT DEFEAT THE GROUND PRONG OF THE AC PLUG!**

17. SPEAKER OUTPUT(S): The SVT-150H has two 1/4" speaker output jacks which you will use to connect to your bass cabinet(s). Use speaker cables with 1/4" plugs to connect the SPEAKER jack(s) to the cabinet(s). Observe the 4 ohm minimum impedance rating. *Please see the note concerning the speaker output jacks on the facing page.*

The following chart shows the total impedance load when connecting speaker cabinets in parallel:

Cabinet Impedance	# of Cabs	Total Impedance
8Ω	2	4Ω
16Ω	2	8Ω
16Ω	4	4Ω

18. EFFECTS RETURN: To use an external effects device or other signal processor, connect the OUTPUT of the device to this jack using a shielded cable. This feeds the processed signal into the amplifier's master section.

19. EFFECTS SEND: Connect the output from this jack to the INPUT of an external effects device using a shielded cable. This sends a post-EQ signal to your effects. Since plugging a cable in here does not break the through connection to the power amp, this can be used as another line out.

20. PRE/POST SWITCH: You can select either pre or post-EQ for the signal at the Balanced Out jack (#22) with this switch. With the switch in the OUT position, the signal at the jacks will be pre-EQ. This is a direct output which is not affected by any EQ or boost settings. With the switch in, the signal is post-EQ and is controlled and modified by the tone controls, Graphic EQ and Effects Loop.

21. -20dB SWITCH: This switch adjusts the output level at the Balanced Out jack (#22). The switch works independently from the front panel Master control. Pushing the switch in activates the -20dB pad, allowing patching into microphone inputs on a mixer without overdriving them.

22. BALANCED OUT: This XLR-type connection supplies a balanced preamp output signal for connecting to a house mixing board, recording console or external amplifiers with balanced inputs. The signal can be set to pre or post-EQ by the Pre/Post switch (#20). The level can be adjusted for either mic or line type inputs using the -20dB switch (#21).

23. FOOTSWITCH: This jack accepts the 1/4" plug from a 1-button footswitch, allowing remote control of the Graphic EQ on/off function. When a footswitch is used, the front panel Master Pull EQ On switch (#11) is bypassed.

The Rear Panel

15. FUSIBLE: Esto protege a la unidad contra daños debidos a condiciones de sobrecarga ó sobretensiones transitorias en la línea de energía. Si el fusible se quema, repóngalo sólo con el mismo tipo y tamaño.

16. ENTRADA DE LA LINEA DE CA: Conecte firmemente a este receptáculo el cable suministrado de corriente de CA, oprimiéndolo hasta que quede totalmente asentado. Enchufe el extremo macho del cordón a una salida aterrizada de CA. **¡NO PASE POR ALTO EL BORNE DE TIERRA DE LA CLAVIJA DE CA!**

17. SALIDA(S) DE LA(S) BOCINA(S): El SVT-150H tiene dos "jacks" de salida para bocinas que usted usará para conectarse a su(s) gabinete(s) de bajos. Use cables para bocinas con clavijas de 1/4" para conectar el (los) "jack(s)" de la(s) BOCINA(S) al (los) gabinete(s). Observe la especificación de 4 ohms de impedancia mínima.

La tabla a continuación muestra la carga de impedancia total cuando se conecten gabinetes de bocinas en paralelo:

Impedancia de cada Gabinete	# de Gabinetes	Impedancia Total
8 ohms	2	4 ohms
16 ohms	2	8 ohms
16 ohms	4	4 ohms

NOTE: In some areas 1/4" speaker jacks are not acceptable for use on amplifiers capable of high output power levels. For this reason the Speaker jacks on your amplifier may resemble the illustration to the right. Connect the amplifier to your speaker(s) using cables rated for very high output power, terminated with the appropriate connectors.

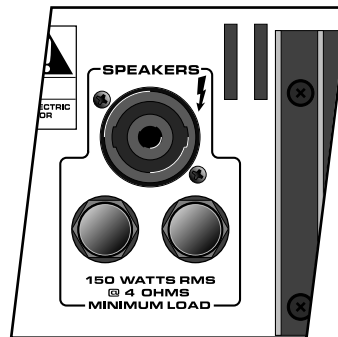

18. RETORNO DE EFECTOS: Para utilizar un dispositivo de efectos externo ú otro procesador de señales, conecte la SALIDA del dispositivo a este "jack" usando un cable blindado. Esto alimenta la señal procesada a la sección maestra del amplificador.

19. ENVIO DE EFECTOS: Conecte la salida de este "jack" a la ENTRADA de un dispositivo de efectos externo usando un cable blindado. Esto envía una señal post-EQ a sus efectos. Siendo que la conexión de un cable en este lugar no rompe la conexión directa al amplificador de potencia, esto se puede utilizar como otra línea hacia afuera.

20. INTERRUPTOR PRE/POST: Usted puede seleccionar por medio de este interruptor ya sea pre ó post-EQ para la señal en el "jack" de Salida Equilibrada (#22). Con el interruptor en la posición de FUERA, la señal en los "jacks" será pre-EQ. Esta es una salida directa no afectada por ningunas posiciones del EQ ó de refuerzo. Con el interruptor hacia adentro, la señal es post-EQ y se controla y modifica mediante los controles de tono, el EQ Gráfico y el Circuito de Efectos.

21. INTERRUPTOR DE -20dB: Este interruptor ajusta el nivel de salida en el "jack" de Salida Equilibrada (#22). El interruptor funciona independientemente del control Maestro del panel delantero. Al oprimirse el interruptor hacia adentro se activa la terminal de los -20dB, lo que permite conectarse a las entradas para micrófonos en un mezclador sin sobreimpulsarlos.

22. SALIDA EQUILBRADA: Esta conexión tipo XLR proporciona una señal de salida equilibrada de preamplificación para conectarse a un tablero mezclador local, una consola grabadora ó amplificadores externos con entradas equilibradas. La señal se puede establecer como pre ó post-EQ mediante el interruptor Pre / Post (#20). El nivel se puede ajustar para entradas de tipos ya sean de micrófono ó de línea utilizando el interruptor de -20dB (#21).

23. INTERRUPTOR DE PIE: Este "jack" acepta la clavija de 1/4" de un interruptor de pie de un solo botón, lo que permite un control remoto de la función de prender / apagar del EQ Gráfico. Cuando se utiliza un interruptor de pie, se pasa por alto el interruptor Maestro para Prender ó Jalar el EQ (#11).



Some Suggested Settings

The setting of the Gain control depends on your particular instrument. The Master should be set to produce the appropriate output volume level. The Graphic EQ can be used to tailor the amplifier to your speaker cabinets, to compensate for room acoustics and to "fine tune" your sound.

ROCK:

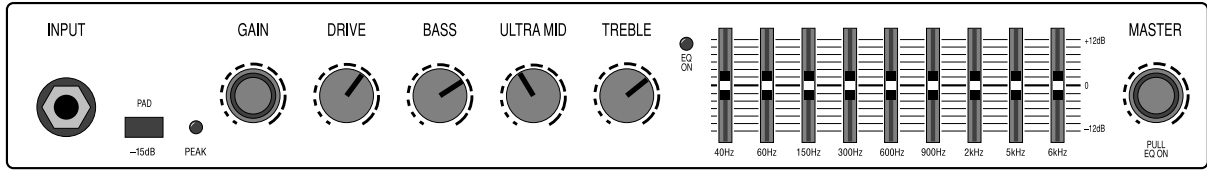

JAZZ:

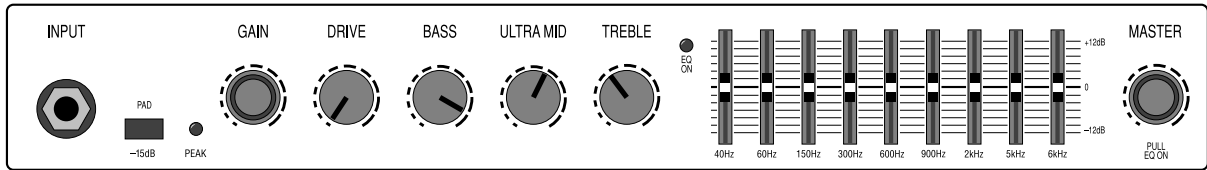

COUNTRY:

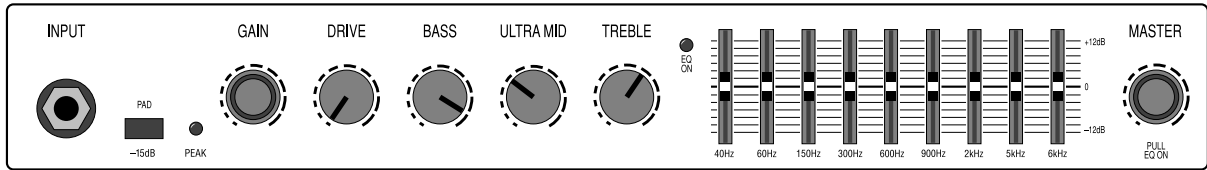

FUNK "POPPING:"

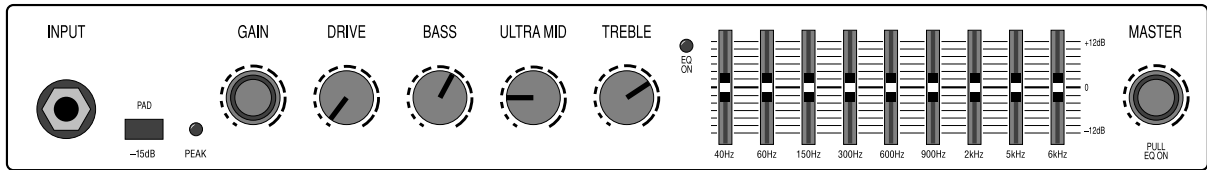

Troubleshooting

In the unlikely event that you SVT-150H should stop working properly (or just stop working), take a few minutes to troubleshoot it before you call for service. You can save yourself a lot of time and sometimes money by doing it yourself, and often the cure for the problem is something quite simple.

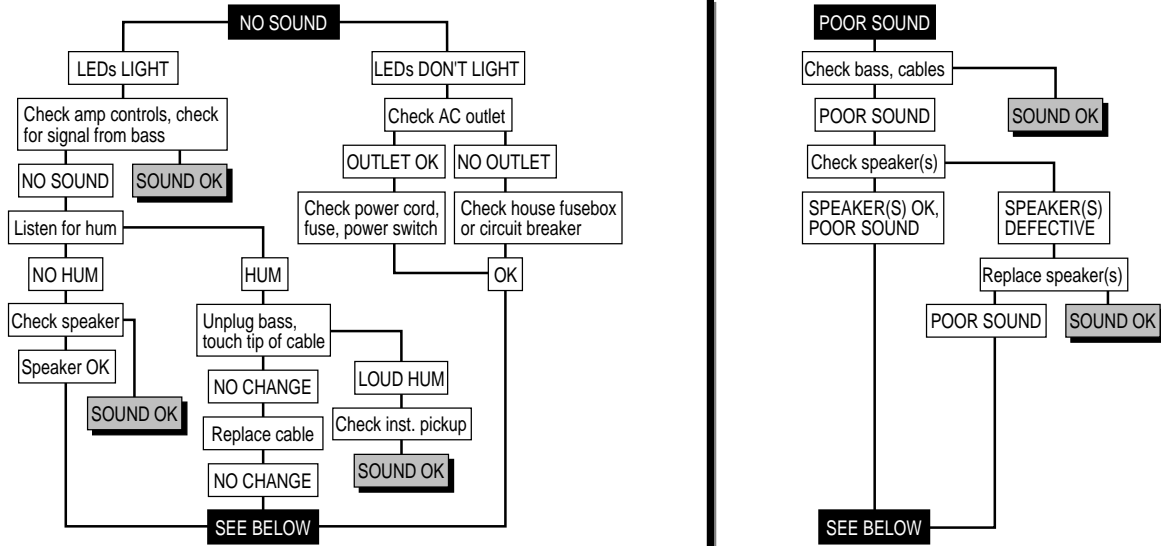

If the problem isn't covered above, or if the steps led you here, then contact your Ampeg dealer for service information. Also, you should refer your amp for servicing if it gets dropped, has liquid spilled into it, or sustains damage to its power cord (see page 2).

System Block Diagram

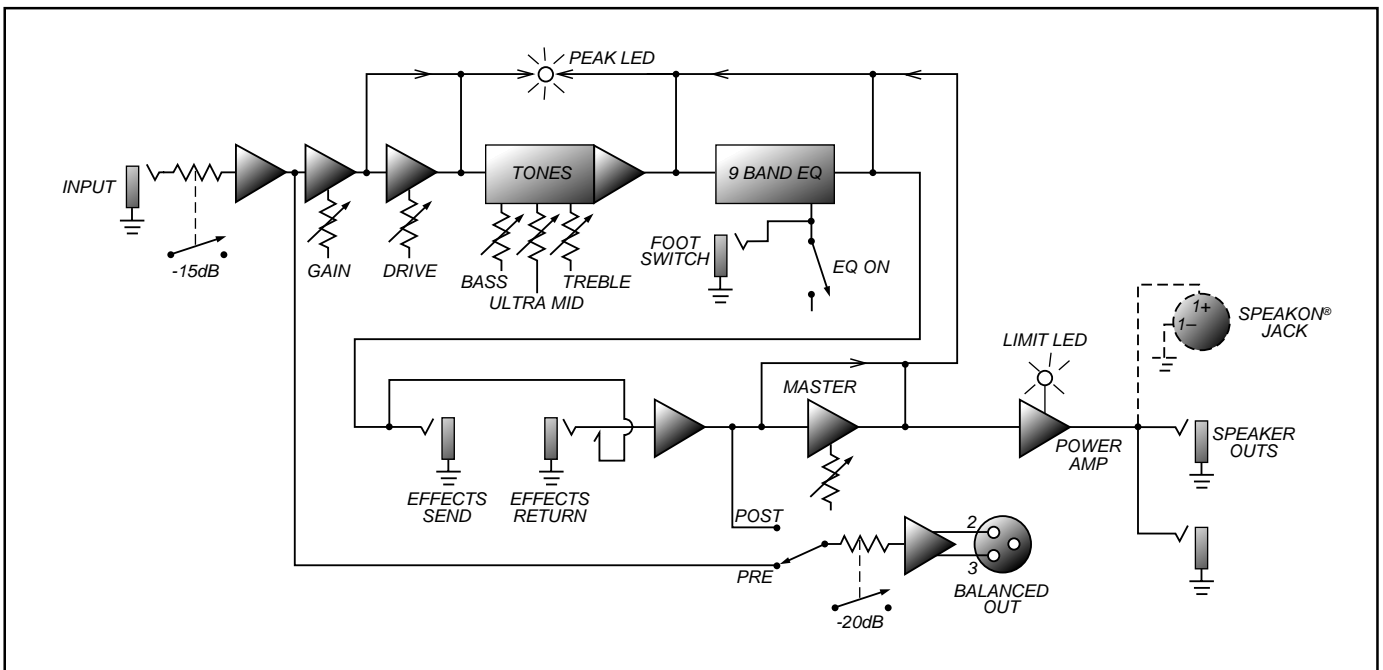



Ampeg

SVT-150H

Technical Specifications

OUTPUT POWER RATING	150 Watts RMS, 4Ω load, 115VAC	
POWER REQUIREMENTS	Domestic: 115VAC, 60Hz, 140VA Export: 100/115VAC, 50/60Hz, 140VA 230VAC 50,60Hz, 140VA	
TONE CONTROL RANGE	Bass: ±8dB @ 50Hz Ultra-Mid: +5, -17dB @500HZ Treble: +17, -22dB @ 5KHZ	
GRAPHIC EQ RANGE	40Hz	±11dB
	80Hz	±8dB
	150Hz	±8dB
	300Hz	±8dB
	600Hz	±8dB
	900Hz	±8dB
	2kHz	±8dB
	5kHz	±9dB
	9kHz	±12dB
GAIN	66dB typical, tones @ center	
SIGNAL TO NOISE RATIO	75dB typical	
SIZE (W x H x D) AND WEIGHT	19"x9.5"x12.5", 30 lbs	



Ampeg reserves the right to change specifications without notice.

Ampeg is proudly Made in America. ©1997 SLM Electronics, 1400 Ferguson Avenue, St. Louis, MO 63133 U.S.A.

